

Series III Multimeter Instruction Sheet

Read First: Safety Information

⚠ To avoid damage to the meter, electric shock or injury:

- Never use the meter if the meter or test leads look damaged.
- Be sure the test leads and rotary switch are in the correct position for the desired measurement.
- Never measure resistance in a circuit when power is applied.
- Never touch the probes to a voltage source when the test leads are plugged into the 10 A or 300 mA input jack.
- Never use the meter on circuits that exceed 4800 volt-amps.
- Never apply more than the rated voltage between any input jack and earth ground.
- Be careful when working with voltages above 60 V dc or 30 V ac rms. Such voltages pose a shock hazard.
- Keep your fingers behind the finger guards on the test probes when making measurements.

⚠ Warning

To avoid false readings, which could lead to possible electric shock or personal injury, replace the battery as soon as the low battery indicator (⊕) appears.

Symbols

- | | |
|---------------|--|
| ⚠ | Caution: Important Information. See instruction sheet. |
| MAN | Manual Range. |
| □ | Double Insulation. |
| ⊕ | Low battery. Replace battery. |
| CAT II | Overvoltage Installation Category per IEC 61010-1-95. CAT II instruments protect against transients from equipment supplied from the fixed installation, e.g., TV, PC, and household appliances. |

Terminals

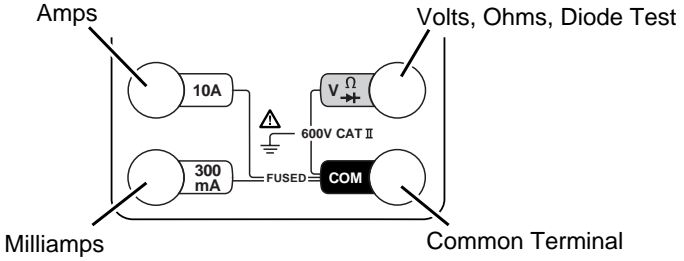

hr2f.eps

See Specifications for overload protection.

Pushbutton

Use the pushbutton to either select a fixed range or put the meter in the Automatic Touch Hold® mode.

Autorange

The meter defaults to autorange when first turned on.

Manual Range

Manual ranging is available in V ac, V dc, ohms, A ac, and A dc.

The manual range mode and Touch Hold mode are mutually exclusive. **MAN** is displayed when the meter is in the manual range mode.

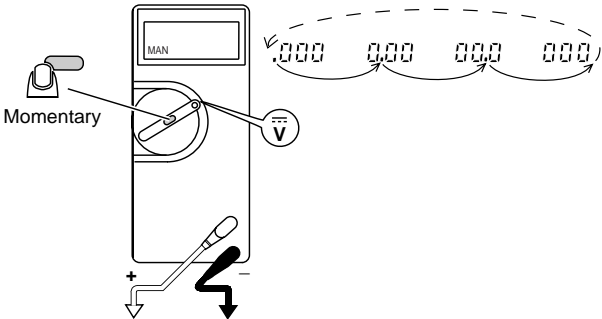

hr14f.eps

To return to autorange, press for 1 second or change the measurement function.

Automatic Touch Hold Mode

⚠ Warning

To avoid electric shock, do not use the Touch Hold® mode to determine if a circuit with high voltage is dead. The Touch Hold mode will not capture unstable or noisy readings.

The Touch Hold mode automatically captures and displays stable readings. Press  for 2 seconds. **HOLD** is displayed when the meter is in the Touch Hold mode.

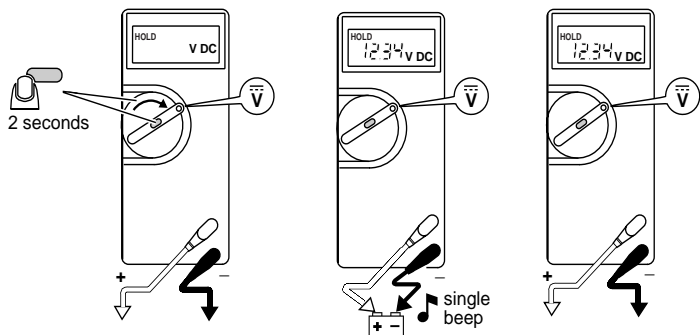

hr3f.eps

When the meter captures a new input, it beeps and a new reading is displayed.

Note

Stray voltages can produce a new reading.

To exit the Touch Hold® mode, press  or change the measurement function. The Touch Hold mode and manual range mode are mutually exclusive.

Bar Graph

The bar graph shows readings relative to the full scale value of a displayed measurement range and indicates polarity.



hr16f.eps

Standby

If the meter is on but is inactive for an hour (20 minutes in diode test), the screen goes blank and displays selected bar graph segments.

To resume operation, turn the rotary switch or press .

AC and DC Voltage (\tilde{V} \bar{V} $m\bar{V}$)

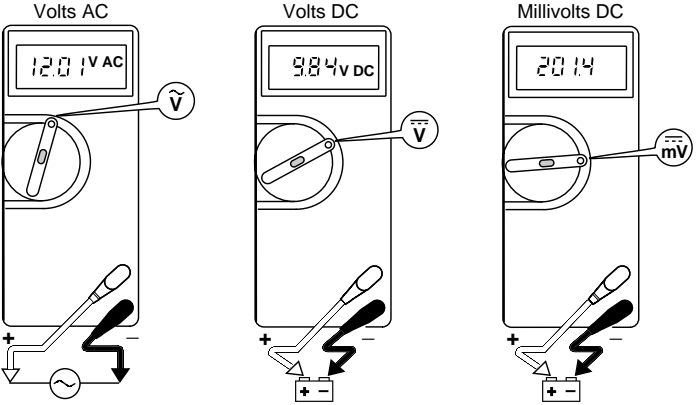

hr4f.eps

Resistance (Ω)

Turn off the power and discharge all capacitors. An external voltage across a component will give invalid resistance readings.

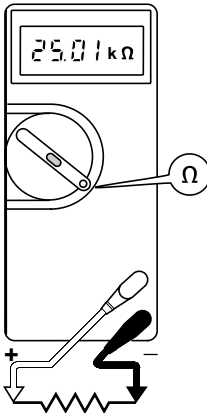

hr6f.eps

Diode Test (→+)

Good Diode

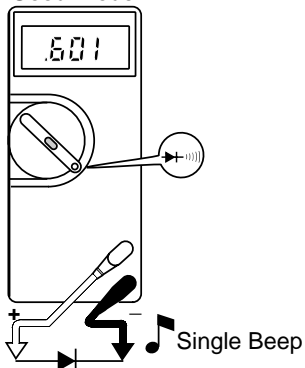

Forward Bias

Good Diode

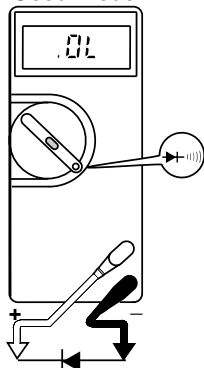

Reverse Bias

Bad Diode

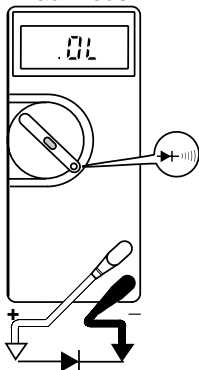

Open

Bad Diode

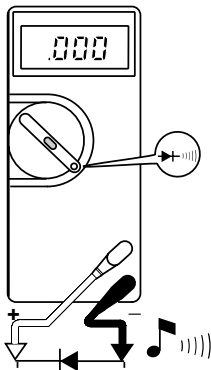

Shorted

Continuity Test ()

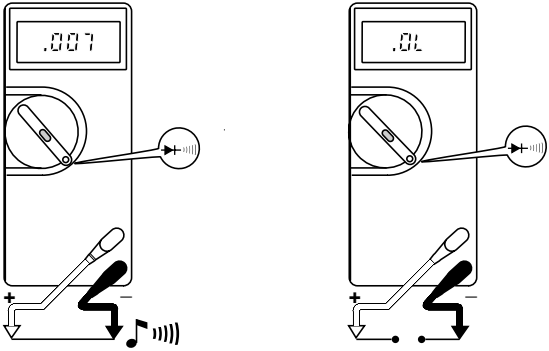

hr5f.eps

If continuity exists (resistance $< 210 \Omega$), the beeper sounds continuously. The meter beeps twice if it is in the Touch Hold® mode.

Current ()

Warning

To avoid injury, do not attempt a current measurement if the open circuit voltage is above the rated voltage of the meter.

To avoid blowing an input fuse, use the 10 A jack until you are sure that the current is less than 300 mA.

Turn off power to the circuit. Break the circuit. (For circuits of more than 10 amps, use a current clamp.) Put the meter in series with the circuit as shown and turn power on.

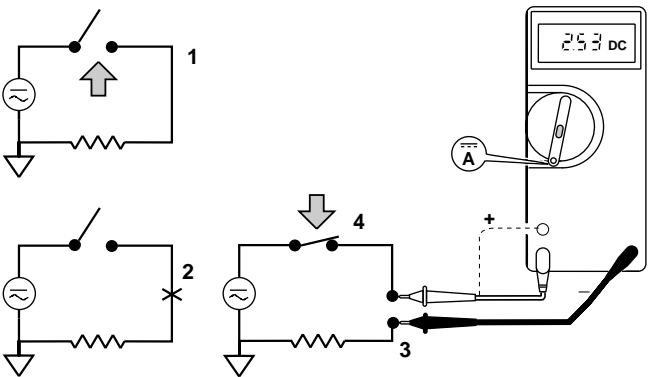

hr8f.eps

Holster

The snap-on holster absorbs shocks and protects the meter and comes with a Flex-Stand™. To protect the front of the meter, put the meter face down in the holster.

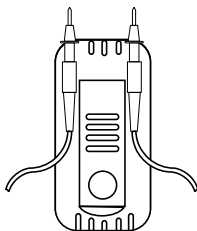
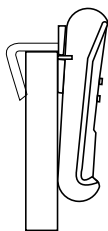

hr15f.eps

Maintenance

⚠ Warning

To avoid electric shock, personal injury, or damage to the meter:

- Do not service this product other than as described in this Instruction Sheet unless you are a qualified technician and have the required equipment and service information.
- Remove any input signals prior to removing test leads and opening case.
- When servicing the meter, use only specified replacement parts.
- Do not allow water to get in the case.

⚠ Caution

To avoid damaging meter components, lift up the end of the battery as shown.

To avoid contamination or static damage, do not touch the circuit board without proper static protection.

For maintenance procedures not described in this Instruction Sheet, contact a Fluke Service Center.

Internal Fuse Test

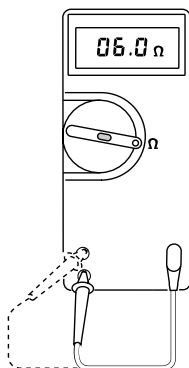

300 mA		10 A			
5-8 Ω		OK	<0.5 Ω		OK
OL		OK	OL		OK

hr10f.eps

Battery and Fuse Replacement

⚠ Warning

To avoid false readings, which could lead to possible electric shock or personal injury, replace the battery as soon as the low battery indicator (⊕) appears.

Note

Before opening the case, make sure the test leads are removed and the rotary switch is turned to OFF.

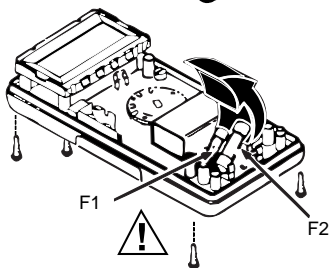
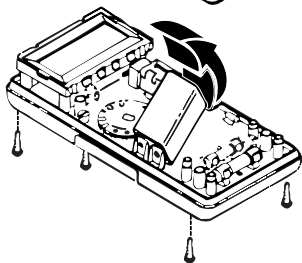
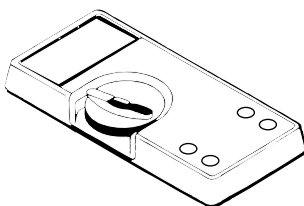
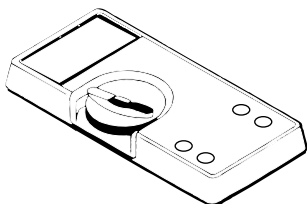

hr11f.eps

Cleaning

To clean the meter, use a damp cloth and mild detergent; do not use abrasives or solvents on the meter.

Contacting Fluke

To contact Fluke, call:

1-888-99-FLUKE (1-888-993-5853) in U.S.A

1-800-36-FLUKE in Canada

+31-402-678-200 in Europe

+81-3-3434-0181 Japan

+65-738-5655 Singapore

+1-425-446-5500 from other countries

Visit Fluke's web site at:

www.fluke.com.

Register your meter online at:

<http://register.fluke.com>.

Item	Description	Part No.	Qty.
BT1	Battery, 9 V, NEDA 1604/IEC 6F22	696534	1
	NEDA 1604A/IEC 6LR61	614487	
F1*	Fuse, F630 mA, 250 V, Min Interrupt Rating 1500 A, IEC 127-1	740670	1
F2*	Fuse, F11 A, 1000 VAC/DC, Min Interrupt Rating 17 kA	803293	1
* For safety, use exact replacement			

General Specifications

Maximum Voltage Between any Terminal and Earth Ground	600 V
Display	Digital: 3,200 counts, updates 2.5/sec Analog: 31 segments, updates 25/sec
Response Time of Digital Display	V ac < 2 s V dc < 1 s Ω < 1 s to 320 k Ω , < 2s to 3.2 M Ω , < 10 s to 32 M Ω
Operating Temperature	0°C to 50°C
Storage Temperature	-40°C to 60°C
Temperature Coefficient	0.1 x (specified accuracy) / °C (<18°C or >28°C)
Electromagnetic Compatibility in RF field of 3 V/m on all functions except M Ω	Total accuracy = Specified accuracy plus +2.0 % of range for all functions except: 320.0 mV range: total accuracy = specified accuracy + 1.0 % of range 320.0 Ω range: total accuracy = specified accuracy + 8 % of range
Relative Humidity except 32 M Ω Range:	0 % to 90 % (0 °C to 35 °C) 0 % to 70 % (35 °C to 50 °C)
32 M Ω Range only:	0 % to 80 % (0 °C to 35 °C) 0 % to 70 % (35 °C to 50 °C)
Altitude	Operating: 2000 meters Storage: 12,000 meters
Battery Type	9 V, NEDA 1604 or 6F22 or 006P, or NEDA 1604A or 6LR61
Battery Life	2000 hrs typical with alkaline 1600 hrs typical with carbon zinc
Continuity Beeper	4096 Hz
Shock, Vibration	per MIL-T-PRF 28800F Class III, Sinusoidal, Non Operating
Size (H x W x L)	2.8 cm x 7.5 cm x 16.6 cm (1.12 in x 2.95 in x 6.55 in)
Weight	340 g (12.0 oz)
Safety	600 V CAT II per ANSI/ISA S82.01-1994, EN 61010-1: 1993, CSA C22.2 No 1010.1-92, UL 3111-1.
EMC Regulations	EN 61326-1: 1997
Certifications/Listings	



Overload protection for all functions and ranges: 600 V.

Function	Input Impedance (Nominal)		
\bar{V} , $m\bar{V}$, \tilde{V}	>10 M Ω , <50 pF		
	Common Mode Rejection Ratio (1 kΩ Unbalanced)	Normal Mode Rejection	
\bar{V} , $m\bar{V}$	>120 dB at dc, 50 Hz, or 60 Hz	>60 dB at 50 Hz or 60 Hz	
\tilde{V}	>60 dB dc to 60 Hz		
	Open Circuit Test Voltage	Full Scale Voltage	
		To 3.2 MΩ	32 MΩ
Ω	<3.1 V dc <2.8 V dc (typical)	<440 mV dc <420 mV dc (typical)	<1.4 V dc <1.3 V dc (typical)
$\rightarrow \vdash \parallel$)	<3.1 V dc	2.0 V dc	
	Typical Short Circuit Current		
Ω	400 μ A		
$\rightarrow \vdash \parallel$)	500 μ A		
$\rightarrow \vdash$	V_F	Typical Test Current	
	0.0 V	0.5 mA	
	0.6 V	0.4 mA	
	1.2 V	0.3 mA	
	2.0 V	0.1 mA	